

### FEATURES

- Low Supply Current ..... 600 $\mu$ A Max
- OP-07 Type Performance
  - Offset Voltage ..... 20 $\mu$ V Max
  - Offset Voltage Drift ..... 0.6 $\mu$ V/ $^{\circ}$ C Max
- Very Low Bias Current
  - 25 $^{\circ}$ C ..... 100pA Max
  - 55 $^{\circ}$ C to +125 $^{\circ}$ C ..... 250pA Max
- High Common-Mode Rejection ..... 114dB Min
- Extended Industrial Temp. Range ..... -40 $^{\circ}$ C to +85 $^{\circ}$ C
- Available in Die Form

### ORDERING INFORMATION <sup>†</sup>

| TO-99   | PACKAGE |                      | OPERATING TEMPERATURE RANGE |
|---------|---------|----------------------|-----------------------------|
|         | CERDIP  | PLASTIC              |                             |
| OP97AJ* | OP97AZ* | -                    | MIL                         |
| OP97EJ  | OP97EZ  | OP97EP               | XIND                        |
| OP97FJ  | OP97FZ  | OP97FP               | XIND                        |
| -       | -       | OP97FS <sup>††</sup> | XIND                        |

\* For devices processed in total compliance to MIL-STD-883, add /883 after part number. Consult factory for 883 data sheet.

<sup>†</sup> Burn-in is available on commercial and industrial temperature range parts in CerDIP, plastic DIP, and TO-can packages.

<sup>††</sup> For availability and burn-in information on SO and PLCC packages, contact your local sales office.

### GENERAL DESCRIPTION

The OP-97 is a low-power alternative to the industry-standard OP-07 precision amplifier. The OP-97 maintains the standards of performance set by the OP-07 while utilizing only 600 $\mu$ A supply current, less than 1/6 that of an OP-07. Offset voltage is an ultra-low 25 $\mu$ V, and drift over temperature is below 0.6 $\mu$ V/ $^{\circ}$ C. External offset trimming is not required in the majority of circuits.

### PIN CONNECTIONS

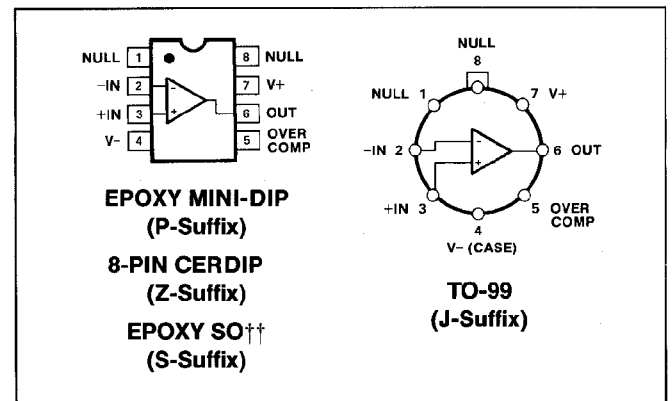

### SIMPLIFIED SCHEMATIC

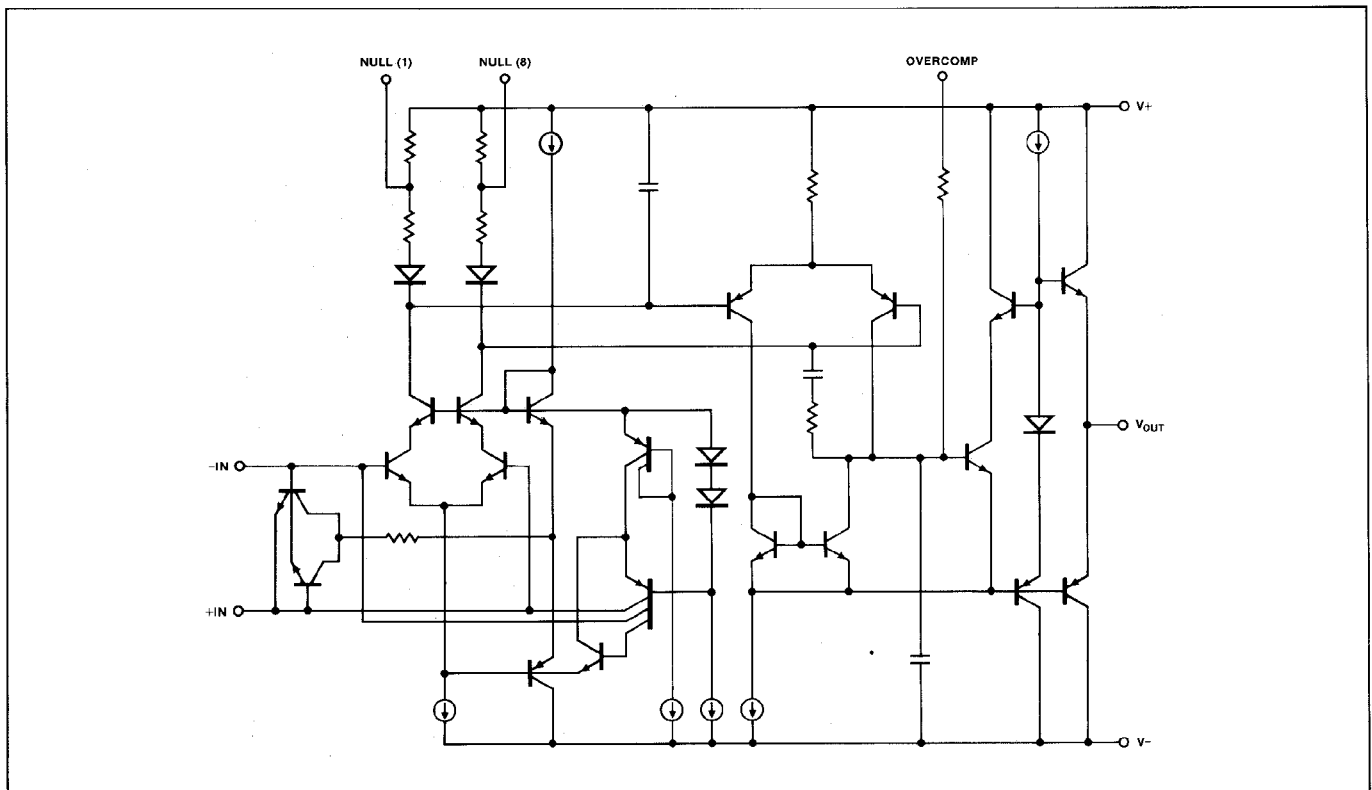

# OP-97

Improvements have been made over OP-07 specifications in several areas. Notable is bias current, which remains below 250pA over the full military temperature range. The OP-97 is ideal for use in precision long-term integrators or sample-and-hold circuits that must operate at elevated temperatures.

Common-mode rejection and power-supply rejection are also improved with the OP-97, at 114dB minimum over wider ranges of common-mode or supply voltage. Outstanding PSR, a supply range specified from  $\pm 2.25V$  to  $\pm 20V$  and the OP-97's minimal power requirements combine to make the OP-97 a preferred device for portable and battery-powered instruments.

The OP-97 conforms to the OP-07 pinout, with the null potentiometer connected between pins 1 and 8 with the wiper to V+. The OP-97 will upgrade circuit designs using 725, OP05, OP07, OP12, and 1012 type amplifiers. It may replace 741-type amplifiers in circuits without nulling or where the nulling circuitry has been removed.

## ABSOLUTE MAXIMUM RATINGS (Note 1)

|   |            |
|---|------------|
| Supply Voltage .....                      | $\pm 20V$  |
| Input Voltage (Note 3) .....              | $\pm 20V$  |
| Differential Input Voltage (Note 4) ..... | $\pm 1V$   |
| Differential Input Current (Note 4) ..... | $\pm 10mA$ |

|  |                                   |
|--|-----------------------------------|
| Output Short-Circuit Duration .....        | Indefinite                        |
| Operating Temperature Range                |                                   |
| OP-97A (J, Z) .....                        | $-55^{\circ}C$ to $+125^{\circ}C$ |
| OP-97E, F (J, P, Z, S) .....               | $-40^{\circ}C$ to $+85^{\circ}C$  |
| Storage Temperature Range .....            | $-65^{\circ}C$ to $+150^{\circ}C$ |
| Junction Temperature Range .....           | $-65^{\circ}C$ to $+150^{\circ}C$ |
| Lead Temperature (Soldering, 60 sec) ..... | $+300^{\circ}C$                   |

| PACKAGE TYPE           | $\theta_{JA}$ (Note 2) | $\theta_{JC}$ | UNITS         |
|------------------------|------------------------|---------------|---------------|
| TO-99 (J)              | 150                    | 18            | $^{\circ}C/W$ |
| 8-Pin Hermetic DIP (Z) | 148                    | 16            | $^{\circ}C/W$ |
| 8-Pin Plastic DIP (P)  | 103                    | 43            | $^{\circ}C/W$ |
| 8-Pin SO (S)           | 158                    | 43            | $^{\circ}C/W$ |

### NOTES:

1. Absolute maximum ratings apply to both DICE and packaged parts, unless otherwise noted.
2.  $\theta_{JA}$  is specified for worst case mounting conditions, i.e.,  $\theta_{JA}$  is specified for device in socket for TO, CerDIP, and P-DIP packages;  $\theta_{JA}$  is specified for device soldered to printed circuit board for SO package.
3. For supply voltages less than  $\pm 20V$ , the absolute maximum input voltage is equal to the supply voltage.
4. The OP-97's inputs are protected by back-to-back diodes. Current-limiting resistors are not used in order to achieve low noise. Differential input voltages greater than 1V will cause excessive current to flow through the input protection diodes unless limiting resistance is used.

## ELECTRICAL CHARACTERISTICS at $V_S = \pm 15V$ , $V_{CM} = 0V$ , $T_A = +25^{\circ}C$ , unless otherwise noted.

| PARAMETER                          | SYMBOL                      | CONDITIONS                         | OP-97A/E   |            |           | OP-97F     |            |           | UNITS                 |
|------------------------------------|-----------------------------|------------------------------------|------------|------------|-----------|------------|------------|-----------|-----------------------|
|                                    |                             |                                    | MIN        | TYP        | MAX       | MIN        | TYP        | MAX       |                       |
| Input Offset Voltage               | $V_{OS}$                    |                                    | —          | 10         | 25        | —          | 30         | 75        | $\mu V$               |
| Long-Term Offset Voltage Stability | $\Delta V_{OS}/\text{Time}$ |                                    | —          | 0.3        | —         | —          | 0.3        | —         | $\mu V/\text{Month}$  |
| Input Offset Current               | $I_{OS}$                    |                                    | —          | 30         | 100       | —          | 30         | 150       | pA                    |
| Input Bias Current                 | $I_B$                       |                                    | —          | $\pm 30$   | $\pm 100$ | —          | $\pm 30$   | $\pm 150$ | pA                    |
| Input Noise Voltage                | $e_{n\ p-p}$                | 0.1Hz to 10Hz                      | —          | 0.5        | —         | —          | 0.5        | —         | $\mu V_{p-p}$         |
| Input Noise Voltage Density        | $e_n$                       | $f_O = 10\text{Hz}$ (Note 2)       | —          | 17         | 30        | —          | 17         | 30        | $nV/\sqrt{\text{Hz}}$ |
|                                    |                             | $f_O = 1000\text{Hz}$ (Note 3)     | —          | 14         | 22        | —          | 14         | 22        | $nV/\sqrt{\text{Hz}}$ |
| Input Noise Current Density        | $i_N$                       | $f_O = 10\text{Hz}$                | —          | 20         | —         | —          | 20         | —         | $fA/\sqrt{\text{Hz}}$ |
| Large-Signal Voltage Gain          | $A_{VO}$                    | $V_O = \pm 10V$ ; $R_L = 2k\Omega$ | 300        | 2000       | —         | 200        | 2000       | —         | V/mV                  |
| Common-Mode Rejection              | CMR                         | $V_{CM} = \pm 13.5V$               | 114        | 132        | —         | 110        | 132        | —         | dB                    |
| Power-Supply Rejection             | PSR                         | $V_S = \pm 2V$ to $\pm 20V$        | 114        | 132        | —         | 110        | 132        | —         | dB                    |
| Input Voltage Range                | IVR                         | (Note 1)                           | $\pm 13.5$ | $\pm 14.0$ | —         | $\pm 13.5$ | $\pm 14.0$ | —         | V                     |
| Output Voltage Swing               | $V_O$                       | $R_L = 10k\Omega$                  | $\pm 13$   | $\pm 14$   | —         | $\pm 13$   | $\pm 14$   | —         | V                     |
| Slew Rate                          | SR                          |                                    | 0.1        | 0.2        | —         | 0.1        | 0.2        | —         | $V/\mu s$             |

**ELECTRICAL CHARACTERISTICS** at  $V_S = \pm 15V$ ,  $V_{CM} = 0V$ ,  $T_A = +25^\circ C$ , unless otherwise noted. (Continued.)

| PARAMETER                     | SYMBOL   | CONDITIONS      | OP-97A/E |          |          | OP-97F  |          |          | UNITS      |
|-------------------------------|----------|-----------------|----------|----------|----------|---------|----------|----------|------------|
|                               |          |                 | MIN      | TYP      | MAX      | MIN     | TYP      | MAX      |            |
| Differential Input Resistance | $R_{IN}$ | (Note 4)        | 30       | —        | —        | 30      | —        | —        | M $\Omega$ |
| Closed-Loop Bandwidth         | BW       | $A_{VCL} = +1$  | 0.4      | 0.9      | —        | 0.4     | 0.9      | —        | MHz        |
| Supply Current                | $I_{SY}$ |                 | —        | 380      | 600      | —       | 380      | 600      | $\mu A$    |
| Supply Voltage                | $V_S$    | Operating Range | $\pm 2$  | $\pm 15$ | $\pm 20$ | $\pm 2$ | $\pm 15$ | $\pm 20$ | V          |

**NOTES:**

1. Guaranteed by CMR test.
2. 10Hz noise voltage density is sample tested. Devices 100% tested for noise are available on request.
3. Sample tested.
4. Guaranteed by design.

**ELECTRICAL CHARACTERISTICS** at  $V_S = \pm 15V$ ,  $V_{CM} = 0V$ ,  $-40^\circ C \leq T_A \leq +85^\circ C$  for the OP-97E/F and  $-55^\circ C \leq T_A \leq +125^\circ C$  for the OP-97A, unless otherwise noted.

| PARAMETER                                   | SYMBOL     | CONDITIONS                      | OP-97A/E   |            |           | OP-97F     |            |           | UNITS            |
|---|------------|---------------------------------|------------|------------|-----------|------------|------------|-----------|------------------|
|   |            |                                 | MIN        | TYP        | MAX       | MIN        | TYP        | MAX       |                  |
| Input Offset Voltage                        | $V_{OS}$   |                                 | —          | 25         | 60        | —          | 60         | 200       | $\mu V$          |
| Average Temperature Coefficient of $V_{OS}$ | $TCV_{OS}$ | S-Package                       | —          | 0.2        | 0.6       | —          | 0.3        | 2.0       | $\mu V/^\circ C$ |
| Input Offset Current                        | $I_{OS}$   |                                 | —          | 60         | 250       | —          | 80         | 750       | pA               |
| Average Temperature Coefficient of $I_{OS}$ | $TCI_{OS}$ |                                 | —          | 0.4        | 2.5       | —          | 0.6        | 7.5       | pA/°C            |
| Input Bias Current                          | $I_B$      |                                 | —          | $\pm 60$   | $\pm 250$ | —          | $\pm 80$   | $\pm 750$ | pA               |
| Average Temperature Coefficient of $I_B$    | $TCI_B$    |                                 | —          | 0.4        | 2.5       | —          | 0.6        | 7.5       | pA/°C            |
| Large-Signal Voltage Gain                   | $A_{VO}$   | $V_O = +10V$ ; $R_L = 2k\Omega$ | 200        | 1000       | —         | 150        | 1000       | —         | V/mV             |
| Common-Mode Rejection                       | CMR        | $V_{CM} = \pm 13.5V$            | 108        | 128        | —         | 108        | 128        | —         | dB               |
| Power-Supply Rejection                      | PSR        | $V_S = \pm 2.5V$ to $\pm 20V$   | 108        | 126        | —         | 108        | 128        | —         | dB               |
| Input Voltage Range                         | IVR        | (Note 1)                        | $\pm 13.5$ | $\pm 14.0$ | —         | $\pm 13.5$ | $\pm 14.0$ | —         | V                |
| Output Voltage Swing                        | $V_O$      | $R_L = 10k\Omega$               | $\pm 13$   | $\pm 14$   | —         | $\pm 13$   | $\pm 14$   | —         | V                |
| Slew Rate                                   | SR         |                                 | 0.05       | 0.15       | —         | 0.05       | 0.15       | —         | V/ $\mu s$       |
| Supply Current                              | $I_{SY}$   |                                 | —          | 400        | 800       | —          | 400        | 800       | $\mu A$          |
| Supply Voltage                              | $V_S$      | Operating Range                 | $\pm 2.5$  | $\pm 15$   | $\pm 20$  | $\pm 2.5$  | $\pm 15$   | $\pm 20$  | V                |

**NOTES:**

1. Guaranteed by CMR test.

# OP-97

## DICE CHARACTERISTICS

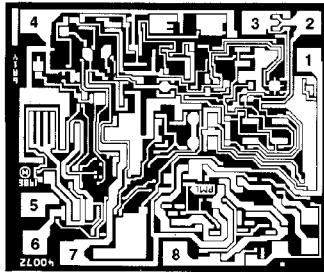

1. NULL
2. INVERTING INPUT
3. NONINVERTING INPUT
4. V-
5. OVERCOMPENSATION
6. OUTPUT
7. V+
8. NULL

**DIE SIZE 0.063 × 0.074 inch, 4,662 sq. mils**  
**(1.60 × 1.88 mm, 3.01 sq. mm)**

**WAFER TEST LIMITS** at  $V_S = \pm 15V$ ,  $V_{CM} = 0V$ ,  $T_A = +25^\circ C$ , unless otherwise noted.

| PARAMETER                    | SYMBOL   | CONDITIONS                             | OP-97N<br>LIMITS | UNITS          |
|------------------------------|----------|--|------------------|----------------|
| Input Offset Voltage         | $V_{OS}$ |  | 250              | $\mu V$ MAX    |
| Input Offset Current         | $I_{OS}$ |  | 150              | pA MAX         |
| Input Bias Current           | $I_B$    |  | $\pm 150$        | pA MAX         |
| Large-Signal<br>Voltage Gain | $A_{VO}$ | $V_{OUT} = \pm 10V$ , $R_L = 2k\Omega$ | 120              | V/mV MIN       |
| Common-Mode Rejection        | CMR      | $V_{CM} = \pm 13.5$                    | 110              | dB MIN         |
| Power-Supply Rejection       | PSR      | $V_S = \pm 2V$ to $\pm 20V$            | 110              | dB MIN         |
| Input-Voltage Range          | IVR      | (Note 1)                               | $\pm 13.5$       | V MIN          |
| Output Voltage Swing         | $V_O$    | $R_L = 10k\Omega$                      | $\pm 13$         | V MIN          |
| Slew Rate                    | SR       |  | 0.1              | V/ $\mu s$ MIN |
| Supply Current               | $I_{SY}$ | No Load                                | 600              | $\mu A$ MAX    |

**NOTES:**

1. Guaranteed by CMR test.

Electrical tests are performed at wafer probe to the limits shown. Due to variations in assembly methods and normal yield loss, yield after packaging is not guaranteed for standard product dice. Consult factory to negotiate specifications based on dice lot qualification through sample lot assembly and testing.

TYPICAL PERFORMANCE CHARACTERISTICS

TYPICAL DISTRIBUTION OF INPUT OFFSET VOLTAGE

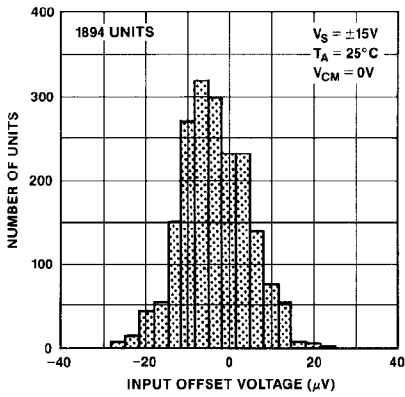

TYPICAL DISTRIBUTION OF INPUT BIAS CURRENT

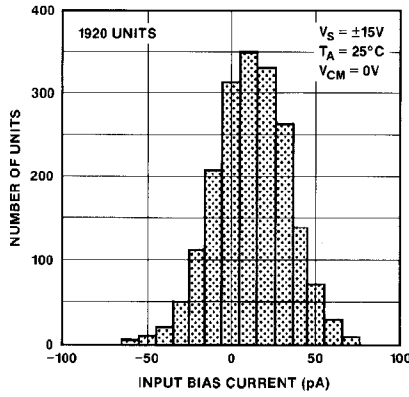

TYPICAL DISTRIBUTION OF INPUT OFFSET CURRENT

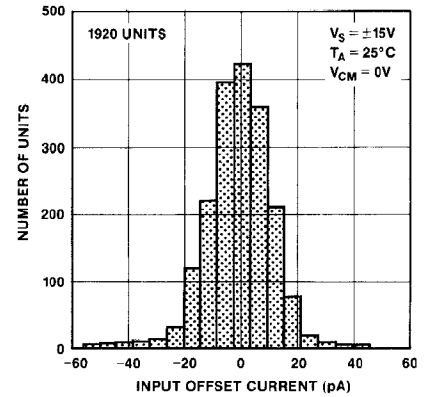

INPUT BIAS, OFFSET CURRENT vs TEMPERATURE

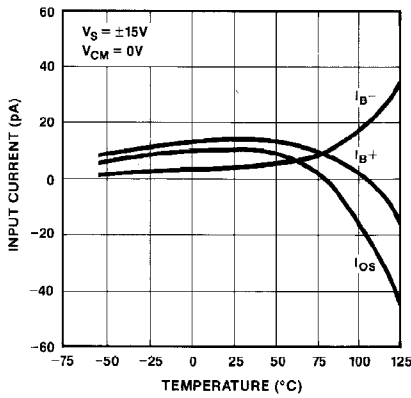

INPUT BIAS, OFFSET CURRENT vs COMMON-MODE VOLTAGE

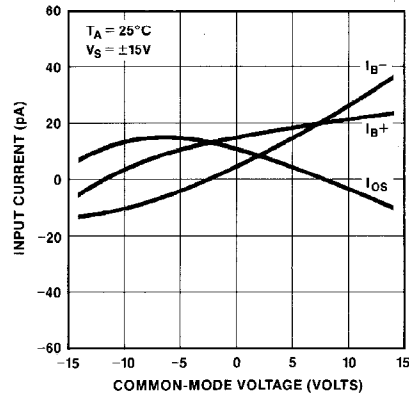

INPUT OFFSET VOLTAGE WARM-UP DRIFT

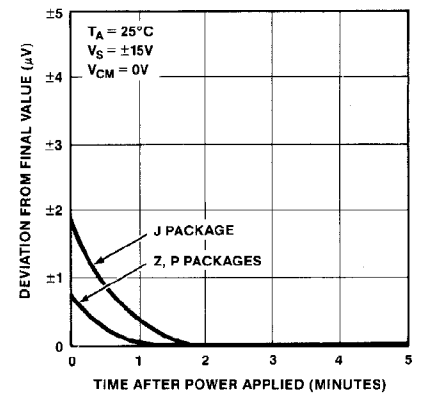

EFFECTIVE OFFSET VOLTAGE vs SOURCE RESISTANCE

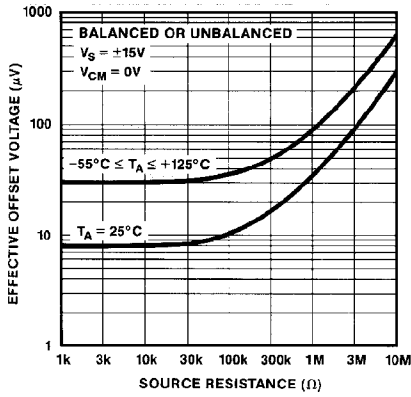

EFFECTIVE TCV\_OS vs SOURCE RESISTANCE

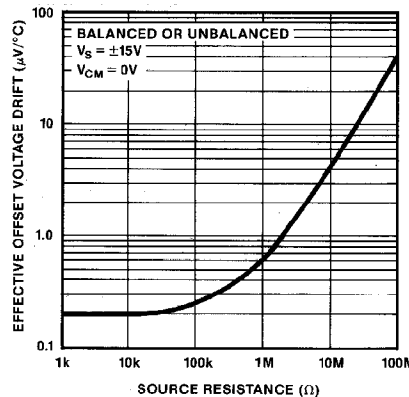

SHORT CIRCUIT CURRENT vs TIME, TEMPERATURE

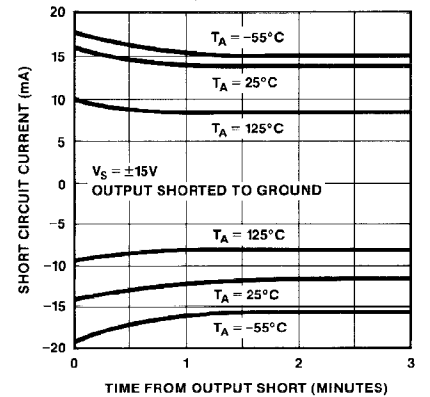

## TYPICAL PERFORMANCE CHARACTERISTICS

### SUPPLY CURRENT vs SUPPLY VOLTAGE

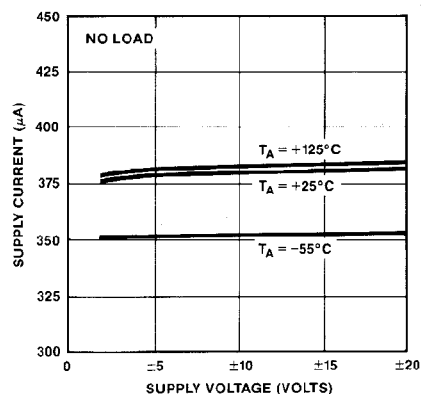

### COMMON-MODE REJECTION vs FREQUENCY

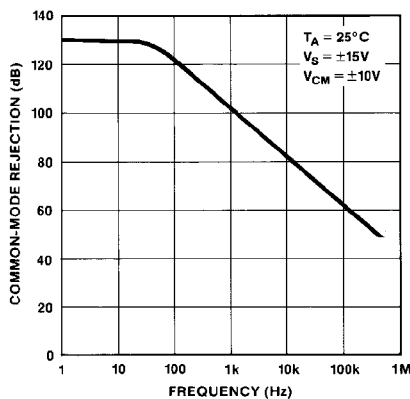

### POWER-SUPPLY REJECTION vs FREQUENCY

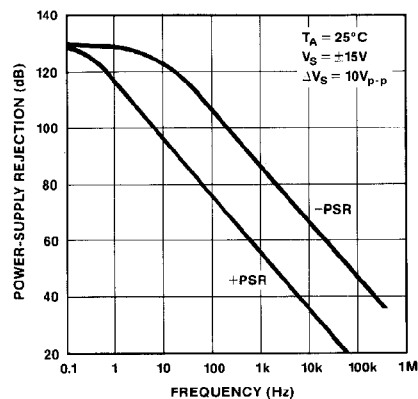

### OPEN-LOOP GAIN vs LOAD RESISTANCE

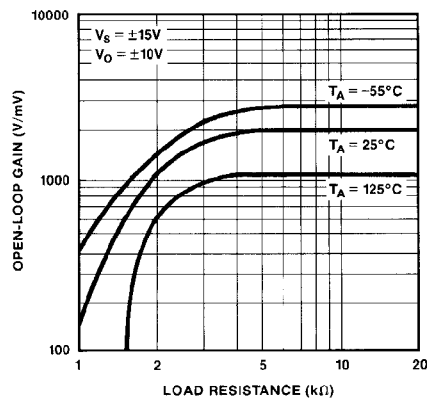

### NOISE DENSITY vs FREQUENCY

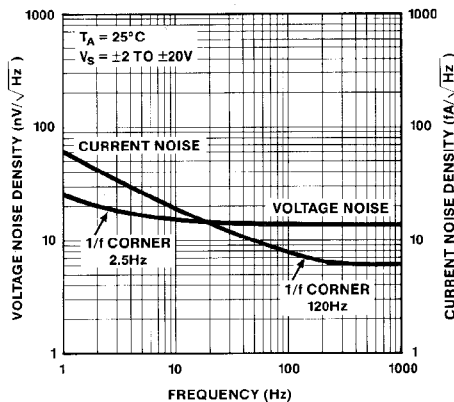

### TOTAL NOISE DENSITY vs SOURCE RESISTANCE

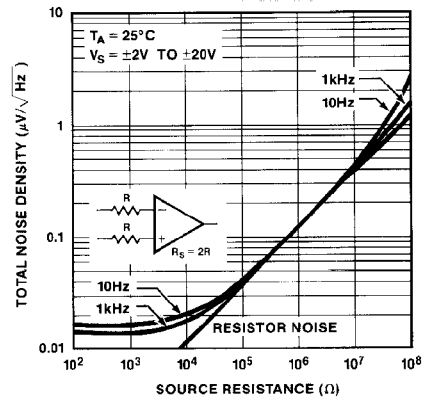

### OPEN-LOOP GAIN LINEARITY

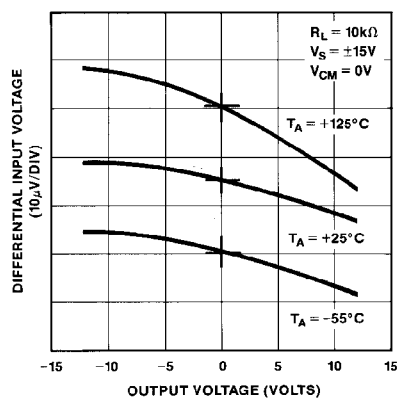

### MAXIMUM OUTPUT SWING vs LOAD RESISTANCE

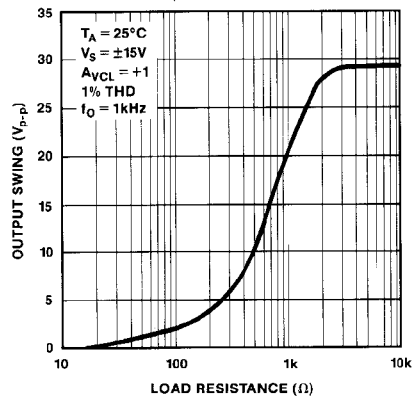

### MAXIMUM OUTPUT SWING vs FREQUENCY

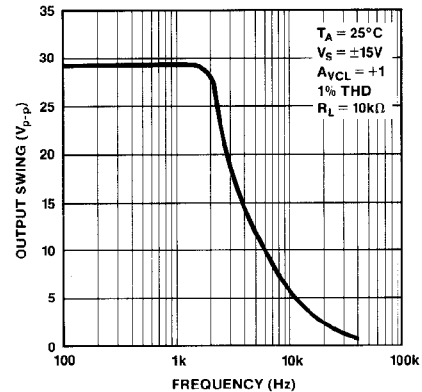

TYPICAL PERFORMANCE CHARACTERISTICS

**OPEN-LOOP GAIN, PHASE vs FREQUENCY**  
( $C_{OC} = 0pF$ )

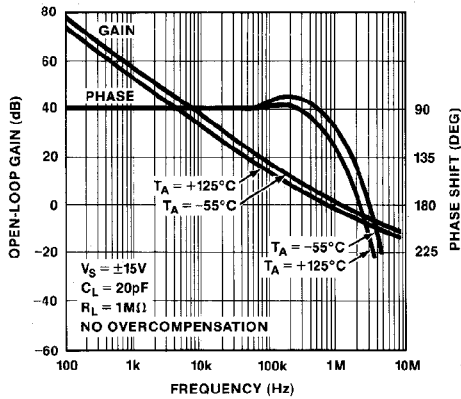

**TOTAL HARMONIC DISTORTION PLUS NOISE vs FREQUENCY**

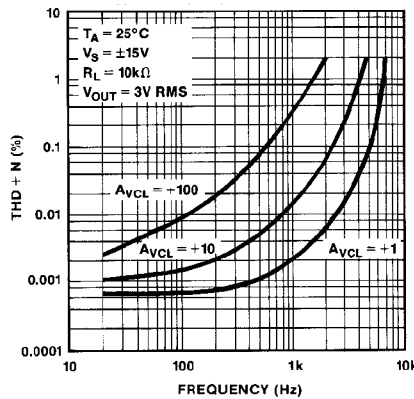

**SMALL-SIGNAL OVERSHOOT vs CAPACITIVE LOAD**

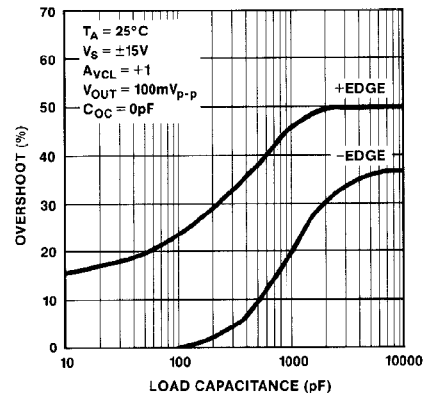

**OPEN-LOOP GAIN, PHASE vs FREQUENCY**  
( $C_{OC} = 100pF$ )

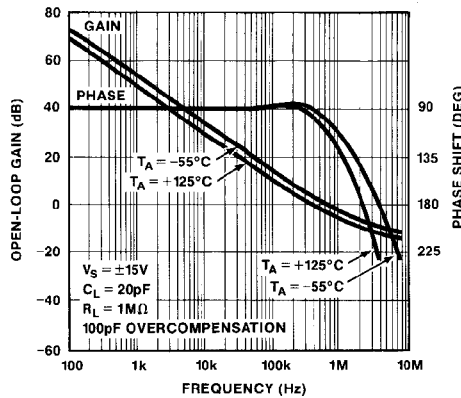

**SLEW RATE vs OVERCOMPENSATION**

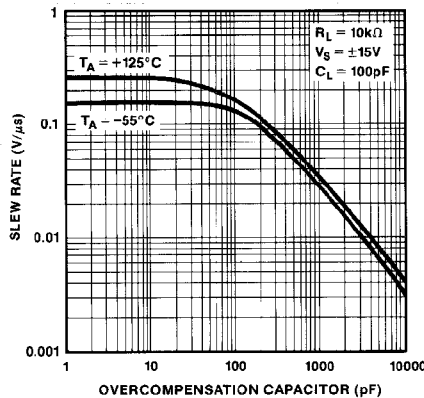

**GAIN-BANDWIDTH PRODUCT vs OVERCOMPENSATION**

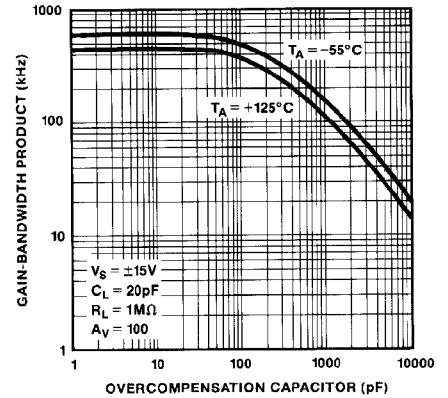

**OPEN-LOOP GAIN, PHASE vs FREQUENCY**  
( $C_{OC} = 1000pF$ )

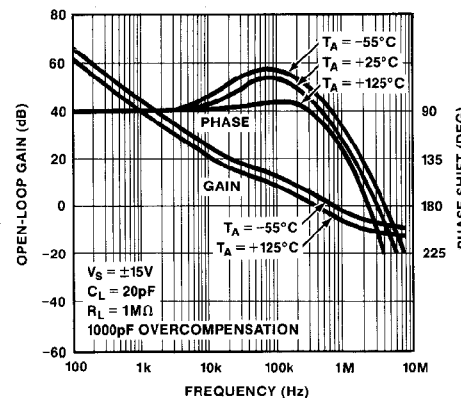

**OPEN-LOOP GAIN, PHASE vs FREQUENCY**  
( $C_{OC} = 10,000pF$ )

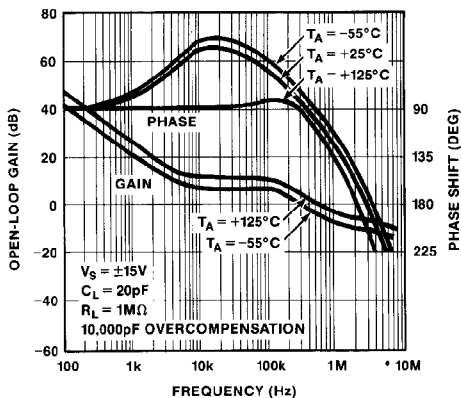

**CLOSED-LOOP OUTPUT RESISTANCE vs FREQUENCY**

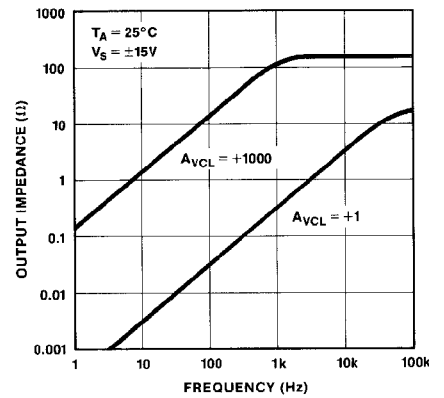

# OP-97

## APPLICATIONS INFORMATION

The OP-97 is a low-power alternative to the industry standard precision op amp, the OP-07. The OP-97 may be substituted directly into OP-07, OP-77, 725, OP-05, 112/312, and 1012 sockets with improved performance and/or less power dissipation, and may be inserted into sockets conforming to the 741 pinout if nulling circuitry is not used. Generally, nulling circuitry used with earlier generation amplifiers is rendered superfluous by the OP-97's extremely low offset voltage, and may be removed without compromising circuit performance.

Extremely low bias current over the full military temperature range makes the OP-97 attractive for use in sample-and-hold amplifiers, peak detectors, and log amplifiers that must operate over a wide temperature range. Balancing input resistances is not necessary with the OP-97. Offset voltage and  $TCV_{OS}$  are degraded only minimally by high source resistance, even when unbalanced.

The input pins of the OP-97 are protected against large differential voltage by back-to-back diodes. Current-limiting resistors are not used so that low-noise performance is maintained. If differential voltages above  $\pm 1V$  are expected at the inputs, series resistors must be used to limit the current flow to a maximum of 10mA. Common-mode voltages at the inputs are not restricted, and may vary over the full range of the supply voltages used.

The OP-97 requires very little operating headroom about the supply rails, and is specified for operation with supplies as low

as  $\pm 2V$ . Typically, the common-mode range extends to within one volt of either rail. The output typically swings to within one volt of the rails when using a  $10k\Omega$  load.

Offset nulling is achieved utilizing the same circuitry as an OP-07. A potentiometer between  $5k\Omega$  and  $100k\Omega$  is connected between pins 1 and 8 with the wiper connected to the positive supply. The trim range is between  $300\mu V$  and  $850\mu V$ , depending upon the internal trimming of the device.

## AC PERFORMANCE

The OP-97's AC characteristics are highly stable over its full operating temperature range. Unity-gain small signal response is shown in Figure 2. Extremely tolerant of capacitive loading on the output, the OP-97 displays excellent response even with  $1000pF$  loads (Figure 3). In large-signal applications, the input protection diodes effectively short the input to the output during the transients if the amplifier is connected in the usual unity-gain configuration. The output enters short-circuit current limit, with the flow going through the protection diodes. Improved large-signal transient response is obtained by using a feedback resistor between the output and the inverting input. Figure 4 shows the large-signal response of the OP-97 in unity-gain with a  $10k\Omega$  feedback resistor. The unity gain follower circuit is shown in Figure 5.

The overcompensation pin may be used to increase the phase margin of the OP-97, or to decrease gain-bandwidth product at gains greater than 10.

**FIGURE 1:** Optional Input Offset Voltage Nulling and Over-compensation Circuits

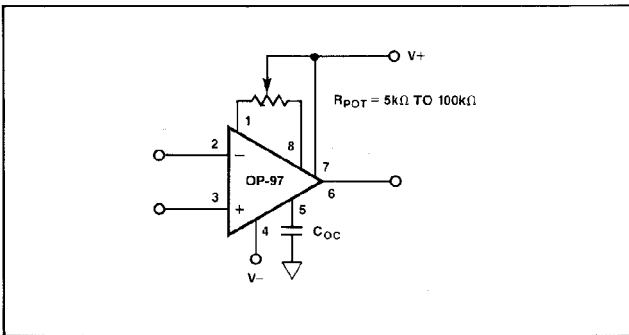

**FIGURE 2:** Small Signal Transient Response ( $C_{LOAD} = 100pF$ ,  $A_{VCL} = +1$ )

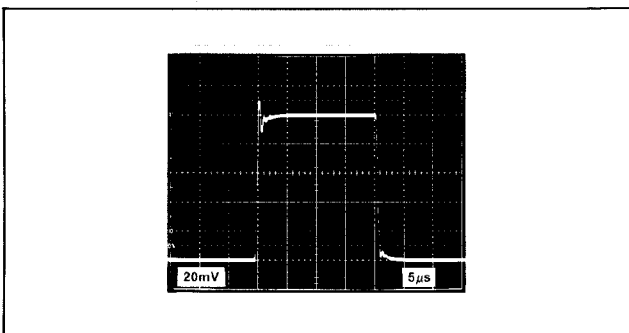

**FIGURE 3:** Small-Signal Transient Response ( $C_{LOAD} = 1000pF$ ,  $A_{VCL} = +1$ )

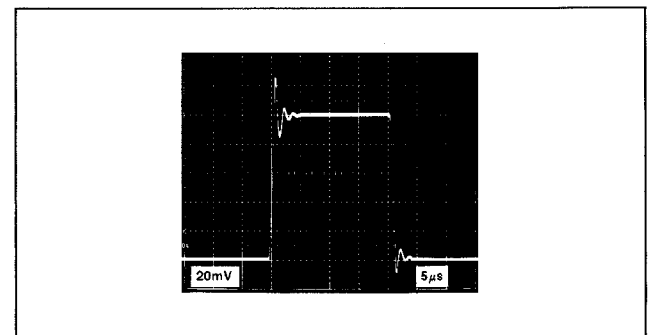

**FIGURE 4:** Large Signal Transient Response ( $A_{VCL} = +1$ )

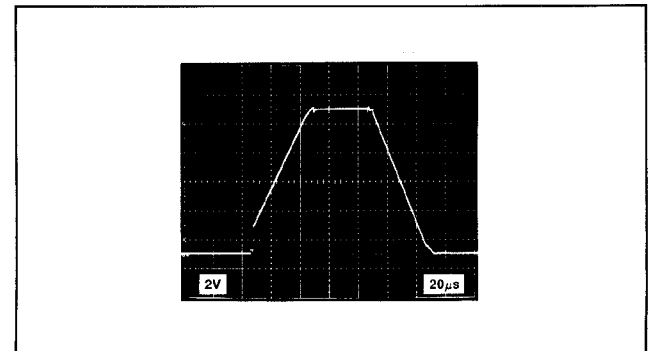



FIGURE 5: Unity-gain Follower

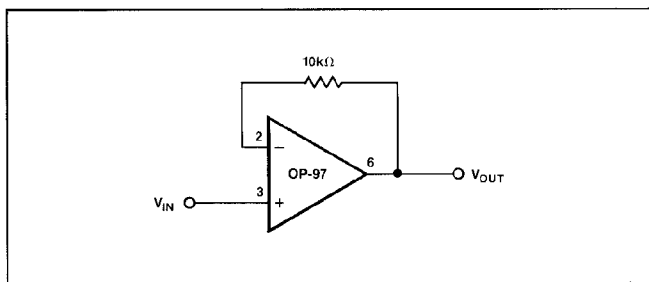
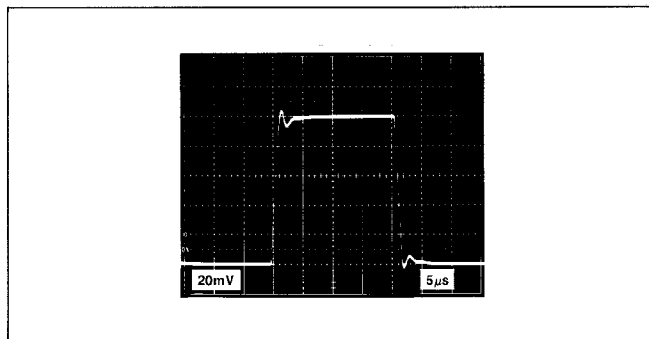

FIGURE 6: Small Signal Transient Response with Overcompensation ( $C_{LOAD} = 1000pF, A_{VCL} = +1, C_{OC} = 220pF$ )



**GUARDING AND SHIELDING**

To maintain the extremely high input impedances of the OP-97, care must be taken in circuit board layout and manufacturing. Board surfaces must be kept scrupulously clean and free of moisture. Conformal coating is recommended to provide a humidity barrier. Even a clean PC board can have 100pA of leakage currents between adjacent traces, so that guard rings

should be used around the inputs. Guard traces are operated at a voltage close to that on the inputs, so that leakage currents become minimal. In noninverting applications, the guard ring should be connected to the common-mode voltage at the inverting input (pin 2). In inverting applications, both inputs remain at ground, so that the guard trace should be grounded. Guard traces should be made on both sides of the circuit board.

FIGURE 8: DAC Output Amplifier

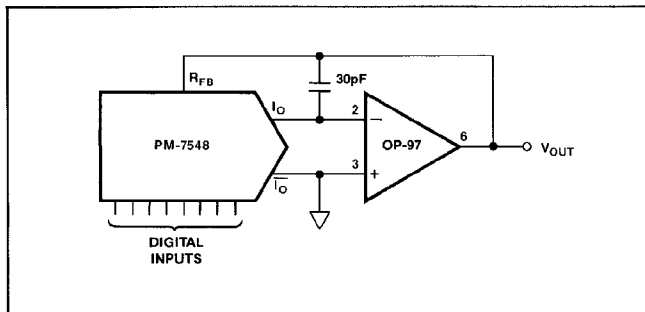

FIGURE 9: Current Monitor

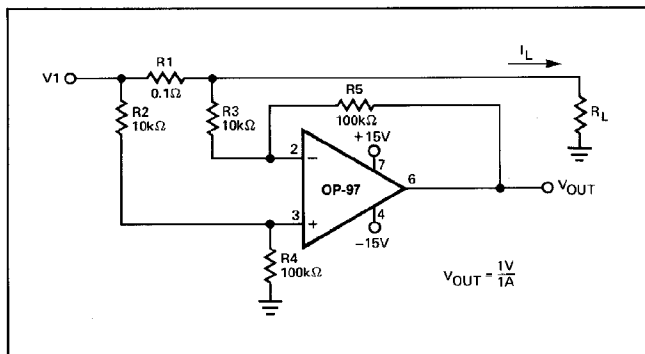
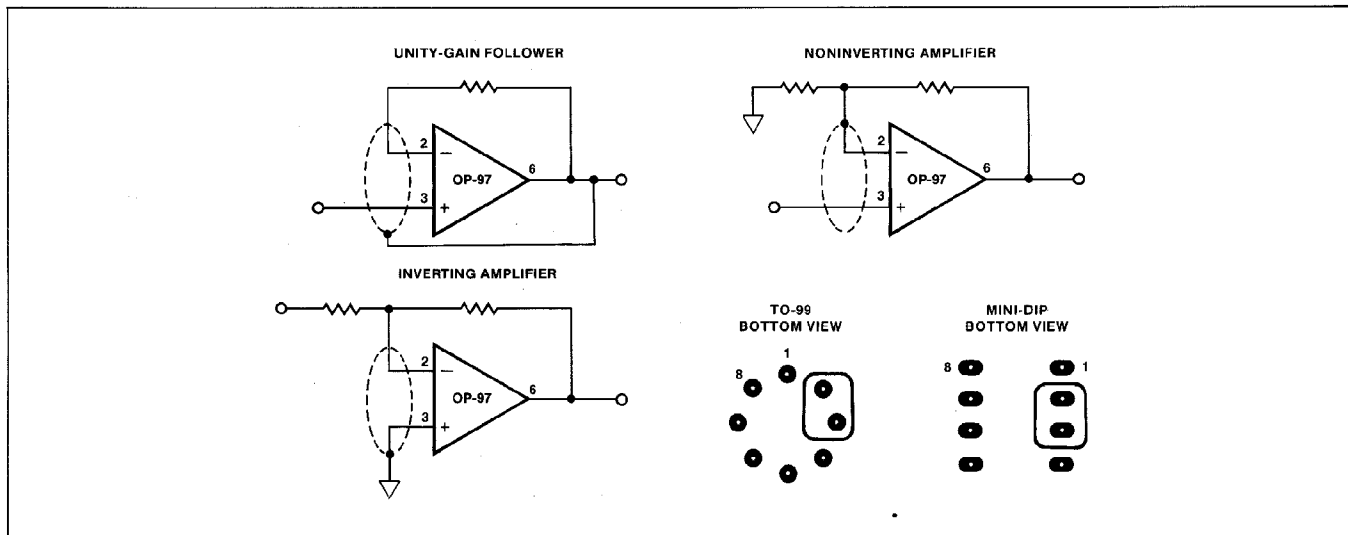

FIGURE 7: Guard Ring Layout and Connections



# OP-97

High impedance circuitry is extremely susceptible to RF pickup, line-frequency hum, and radiated noise from switching power-supplies. Enclosing sensitive analog sections within grounded shields is generally necessary to prevent excessive noise pickup. Twisted-pair cable will aid in rejection of line-frequency hum.

The OP-97 is an excellent choice as an output amplifier for higher resolution CMOS DACs. Its tightly trimmed offset voltage and minimal bias current result in virtually no degradation of linearity, even over wide temperature ranges.

Figure 9 shows a versatile monitor circuit that can typically sense current at any point between the  $\pm 15V$  supplies. This makes it ideal for sensing current in applications such as full bridge drivers where bi-directional current is associated with large common-mode voltage changes. The 114dB CMRR of the OP-97 makes the amplifier's contribution to common-mode error negligible, leaving only the error due to the resistor ratio inequality. Ideally,  $R2/R4 = R3/R5$ . This is best trimmed via R4.

The digitally programmable gain amplifier shown in Figure 10 has 12-bit gain resolution with 10-bit gain linearity over the range of  $-1$  to  $-1024$ . The low bias current of the OP-97 maintains this linearity, while C1 limits the noise voltage bandwidth allowing accurate measurement down to microvolt levels.

| DIGITAL IN | GAIN ( $A_V$ ) |
|------------|----------------|
| 4095       | -1.00024       |
| 2048       | -2             |
| 1024       | -4             |
| 512        | -8             |
| 256        | -16            |
| 128        | -32            |
| 64         | -64            |
| 32         | -128           |
| 16         | -256           |
| 8          | -512           |
| 4          | -1024          |
| 2          | -2048          |
| 1          | -4096          |
| 0          | OPEN LOOP      |

Many high-speed amplifiers suffer from less-than-perfect low-frequency performance. A combination amplifier consisting of a high precision, slow device like the OP-97 and a faster device such as the OP-44 results in uniformly accurate performance from DC to the high-frequency limit of the OP-44, which has a gain-bandwidth product of 23MHz. The circuit shown in Figure 11 accomplishes this, with the OP-44 providing high-frequency amplification and the OP-97 operating on low-frequency signals and providing offset correction. Offset voltage and drift of the circuit are controlled by the OP-97.

FIGURE 10: Precision Programmable Gain Amplifier

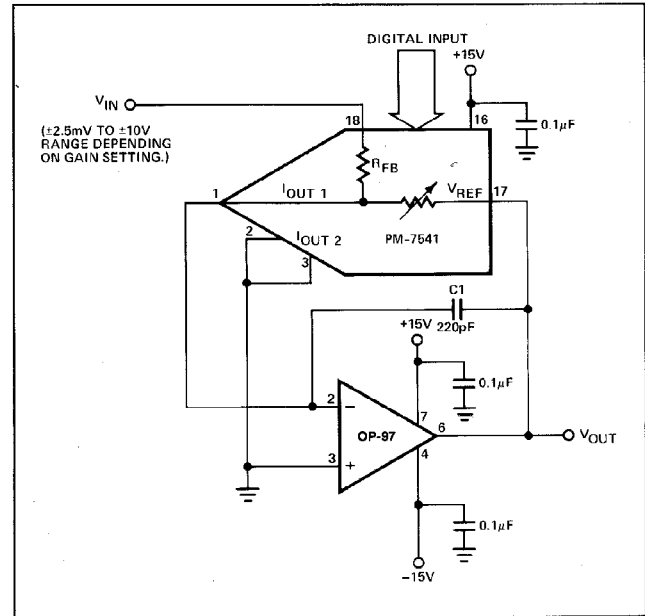

FIGURE 11: Combination High-Speed, Precision Amplifier

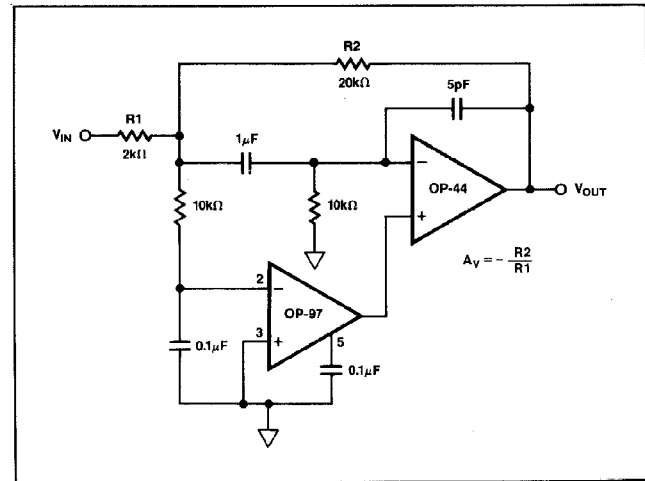

FIGURE 12: Combination Amplifier Transient Response

